



ND9322P ND9424P

H.265 8-CH/16-CH
Embedded Plug & Play NVR



H.265/H.264 • 4K Display • 8/16 x PoE Port • RAID 0, 1 •
Fisheye Dewarp • Trend Micro IoT Security • VIVOCLOUD

VIVOTEK's ND9322P/ND9424P is a new generation H.265 Linux-based standalone NVR that supports up to 4K IP camera video decoding and local 4K video display. With advanced H.265 compression technology, users are able to experience Full HD quality video while expending less HDD capacity than H.264.

The NVR features embedded 8/16x 802.3 at/af PoE ports to provide users easy and convenient IP camera installation, and also supports remote and mobile access via VIVOCLOUD and iViewer apps for both iOS and Android devices. The VIVOCLOUD app provides instant push notification and direct video playback

functions when triggered by an alarm notification and provides users a flexible and intelligent NVR for seamless use in small to medium sized video surveillance applications.

Users of the NVR will also benefit from VIVOTEK's cooperation with world-renowned cybersecurity company, Trend Micro. Through network cameras armed with Trend Micro's anti-intrusion software, VIVOTEK unites high security and robust network surveillance to secure lives and protect data across diverse applications.

Key Features

- H.265/H.264 Compression Technology
- 4K Display for Clear Monitoring
- Live and Playback Fisheye Dewarp
- VIVOTEK's Smart Stream II to Optimize Bandwidth Efficiency
- Trend Micro IoT Security within Standard Warranty Period
- 802.3at/af Compliant PoE port x 8/16
- VIVOCLOUD App & Portal for 24/7 Viewing
- RAID 0, 1 Supported to Prevent from Recording Data Loss
- Remote Schedule Backup to FTP
- POS Integration (Project Support Function)
- Multiple Browsers Supported: IE, Chrome, and Firefox on both Windows & macOS
- Supports VCA Counting Solution

Highlight Features

Better Video Quality with Lower Bandwidth

With H.265 standard and VIVOTEK's Smart Stream technology, VIVOTEK NVR is not only able to provide the high quality video, also save the usage of network bandwidth and recording capacity more than regular H.264 standard.

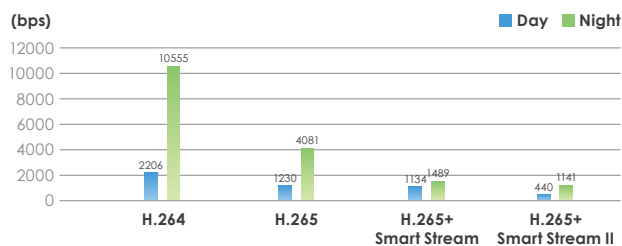

4K IP Camera Video Input and 4K Local Video Output

Supporting 4K IP camera video input and 4K local video output, VIVOTEK's NVR can provide users extra high definition video resolution ensuring they will never miss a single detail in both video monitoring and recording.



4K Resolution

Trend Micro IoT Security

In collaboration with industry-leading cybersecurity software partners, VIVOTEK focuses on making network security products and software that meet industry protocols as well as constantly developing shields to increase your protection from various cyberattacks. By choosing VIVOTEK solutions, users can experience not only high-quality products, but also safer network environments.

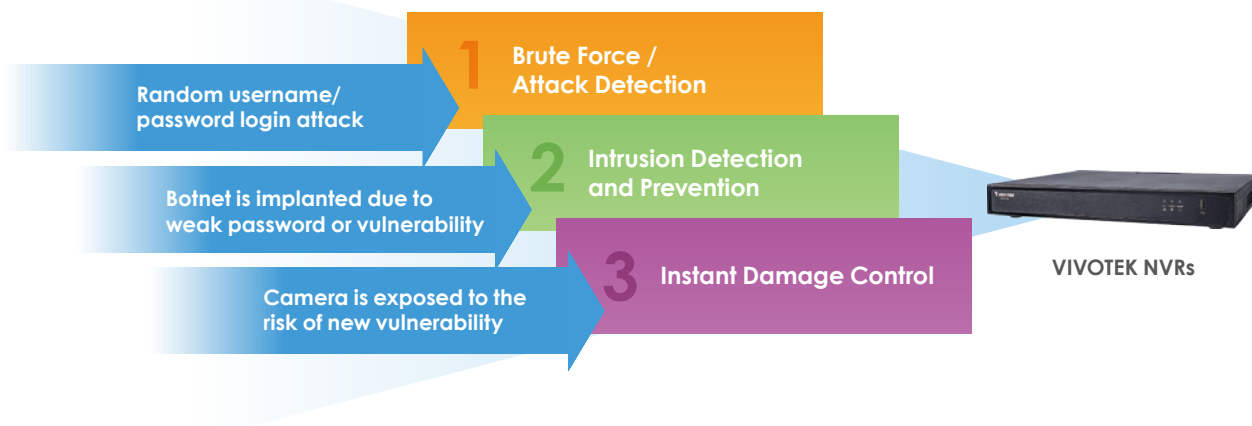

Fisheye Dewarp

VIVOTEK's NVR offers both LiveView and Playback modes for one fisheye network camera simultaneously. They also provide multiple fisheye de-warp display modes, including 1O, 1P, 1R, 1O3R, 1O8R, allowing users to monitor any angle, or to enjoy precise detailed images for a total surveillance experience.

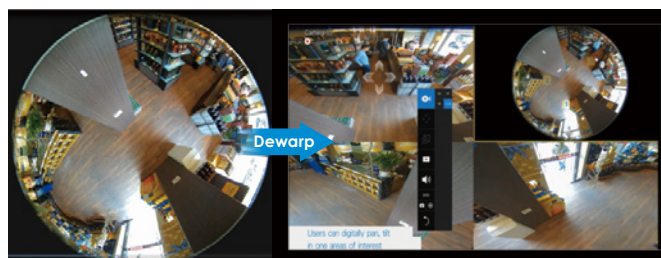

Highlight Features

VCA Counting Solution

The NVR supports VIVOTEK's counting cameras and counting data storage. In local display mode, it can display the counting rule and the detected object information, as well as send that data to VIVOTEK's backend system for counting results analysis.

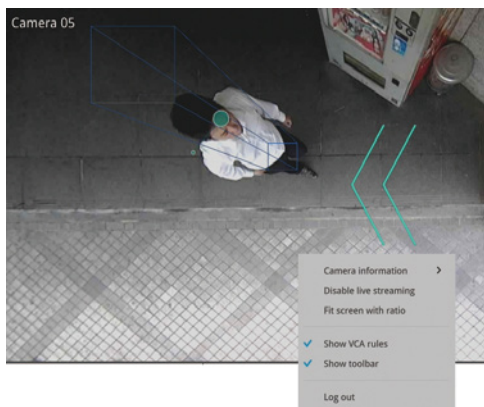

Chrome & Firefox Now Supported

Support for plug-in free web browsers enables users with direct web viewing/setting on IE, and now also on Chrome and Firefox web browsers, for both Windows and macOS.



VIVOCLOUD App & Portal for 24/7 Viewing

The free VIVOCLOUD app makes surveillance lightweight and portable, ensuring efficient operation. The latest P2P technology makes remote access even more convenient, by simply scanning the QR-code and installing the app, users can view live streams and play recorded clips with the intuitive interface anytime, anywhere. Armed with the Push Notification function, users will directly get an alert message on their Android/iOS mobile device and directly playback the video to check for any suspicious activity.

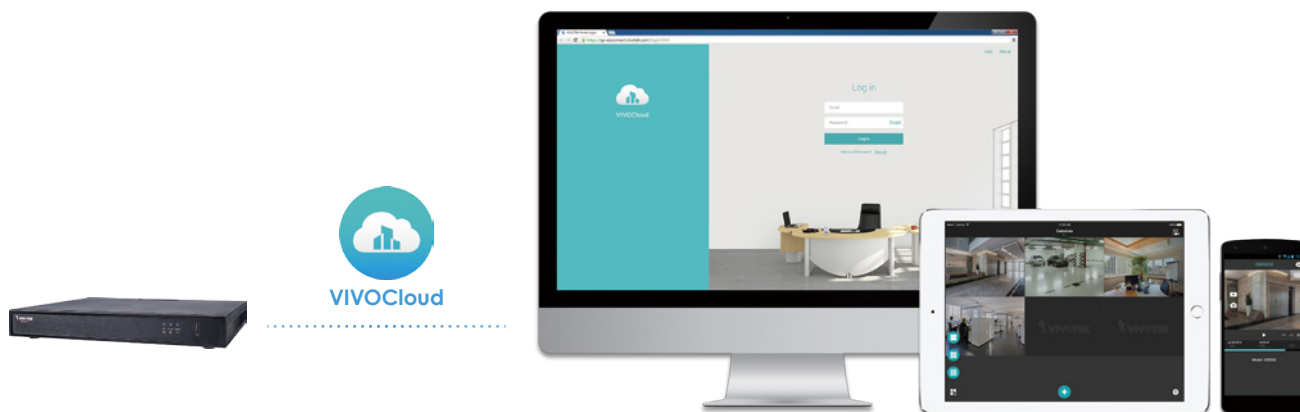

Technical Specifications

Model	ND9322P	ND9424P
Form Factor	H.265 8-CH Embedded Plug & Play NVR	H.265 16-CH Embedded Plug & Play NVR
System		
OS	Embedded Linux	
CPU	ARM processor	
Flash	256MB	
RAM	1GB	2GB
Watchdog	Hardware + Software	
Power Restoration	System restart automatically after power recovery	
Local Display		
Live View Display	8 Channels Multi-layout display: 1x1, 3V, 2x2, 3x3, 1P+3, 1M+5, 1P+6	16 Channels Multi-layout display: 1x1, 3V, 2x2, 3x3, 1P+3, 1M+5, 1P+6, 1M+12, 4x4
Video Output	HDMI x1, VGA x1	
Display Resolution	3840x2160, 1920x1080, 1280x720	
Camera Position	Change the viewcell position on the Live View screens	
Stream Application	Constant/Auto adaptive stream	
Monitor Enhancement	OSD display (NVR), OSD display (camera), camera information, remote I/O control, event notification, aspect ratio	
Fisheye Dewarp	1O, 1P, 1R, 1O3R, 1O8R	
PTZ Operation	Direction control, home, iris, preset, patrol (group), PiP control	
Video		
Video Format	H.265, H.264, MJPEG	
Graphics Decoder	Hardware decoding	
Decoding Resolution	Up to 3840x2160	
Decoding Capability	3840x2160 @ 30 fps (1-CH) 1920x1080 @ 120 fps (4-CH) 1280x720 @ 240 fps (8-CH)	3840x2160 @ 30 fps (1-CH) 1920x1080 @ 120 fps (4-CH) 1280x720 @ 240 fps (8-CH) 720x240 @ 480 fps (16-CH)
Audio		
Audio Format	G.711, G.726	
Audio In/Out	3.5 phone jack audio output x1 3.5 phone jack audio input (reserved) x1	
Record		
Recording Time (sec.)	Pre-Record: 5 (Max. 10) Post-Record: 20 (Max. 300)	
Recording Stream	Single	
Recording Throughput	64 Mbps	96 Mbps
Recording Mode	Continuous, schedule, manual, event, activity adaptive streaming	
Recording Setting	Recycle (unit: day)	
Watermark	Supported	
Storage		
HDD Devices	Internal x2 (3.5" HDD)	

Technical Specifications

Model	ND9322P	ND9424P
Form Factor	H.265 8-CH Embedded Plug & Play NVR	H.265 16-CH Embedded Plug & Play NVR
HDD Max. Capacity	8TB	
RAID	RAID 0, 1	
Disk Management	Create, format, remove disk HDD S.M.A.R.T.	
Local Backup	USB dongle (FAT format)	
Schedule Backup	FTP	
Playback		
Playback Display	4 Channels Multi-layout display: 1x1, 2x2, 1P+3, 1V+3	
Playback Control	Regular (play, pause, stop), rewind, next /previous frame, speed control, calendar, event, timeline, timeline scale, thumbnail (storyboard)	
Video Search	by calendar, date/time, alarm	
Thumbnail Explorer (Storyboard)	Listing the thumbnail of recorded video (Max. 2-CH)	
Snapshot	JPEG	
Video Clip Export	EXE	
Network		
Ethernet	10/100/1000Mbps Ethernet (RJ-45) x1	
Video Throughput for Remote Client	24 Mbps	
PoE	802.3at/af compliant PoE ports x8 (total Max. 120W)	802.3at/af compliant PoE ports x16 (total Max. 200W)
Protocols	IPv4, TCP/IP, HTTP, HTTPS, UPnP, RTSP/RTP/RTCP, SMTP, FTP, DHCP, NTP, DNS, DDNS, IP Filter	
External Interface		
USB	Front x1 (USB 2.0) Back x1 (USB 3.0)	
Alarm In	4	
Alarm Out	1	
Audio	3.5 phone jack audio output x1 3.5 phone jack audio input (reserved) x1	
System		
POS Integration	Supported (request by project)	
UPS Integration	Supported (request by project)	
Camera Integration	ONVIF Profile S	
Event	Camera: motion detection, PIR detection, tampering detection, DI/DO, disconnection System: storage abnormal, storage full, DI/DO	
Event Action	Video recording, email with snapshot, buzzer, PTZ, FTP, DO (camera, system), full screen, send to CMS, VIVOCloud APP notification	
User Management	User level: administrator, regular user	
Log	System, recording, user, error	
Date & Time	Time zone, manual, automatic sync NTP, daylight saving time	
Advanced Features		
VCA Counting Solution	Supported	

Technical Specifications

Model	ND9322P	ND9424P
Form Factor	H.265 8-CH Embedded Plug & Play NVR	H.265 16-CH Embedded Plug & Play NVR
Trend Micro IoT Security	Supported	
Remote Client		
Software AP	Shepherd, VAST 2	
Mobile/Tablet App	iViewer (Android & iOS)	
Web Browser	Internet Explorer 10 (32 bit) or above/ Windows Chrome v68.0.3 & Firefox v61.02 or above/ Windows & macOS	
VIVOCLOUD	Supported	
General		
Power Input	100-240V AC, 50/60Hz	
Power Consumption	Max. 170 W	Max. 250 W
Dimensions	360 (W) x 311 (D) x 44 (H) mm	
Weight	3.16 kg (without HDD)	3.21 kg (without HDD)
Operating Temperature	0°C ~ 40°C (32°F ~ 104°F)	
Humidity	0 ~ 95%	
Safety Certifications	CE, FCC, VCCI, C-Tick, UL, CB, BSMI	
Warranty	24 months	
Dimensions		

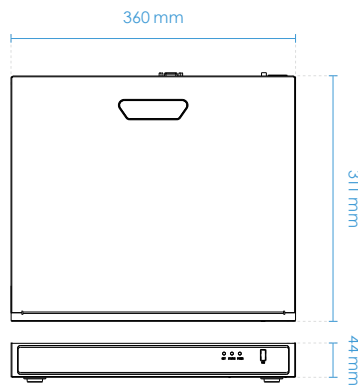

Product - Order Information

Model	Description	P/N
ND9322P	H.265, 8CH, 8 PoE, 2HDD NVR	100194000G, US
		100194010G, EU
		100194020G, UK
		100194030G, AU
ND9424P	H.265, 16CH, 16 PoE, 2HDD NVR	100193900G, US
		100193910G, EU
		100193920G, UK
		100193930G, AU

Accessory - Order Information

Model	Description
AM-611	Rack Mount Ear Bracket

Mechanical Information - ND9424P

Front View



- 1 LED Indicators
- 2 USB 2.0
- 3 100-240V AC Power Input
- 4 4 x Alarm In
1 x Alarm Out

- 5 Audio In/Out
- 6 VGA
- 7 HDMI

Back View

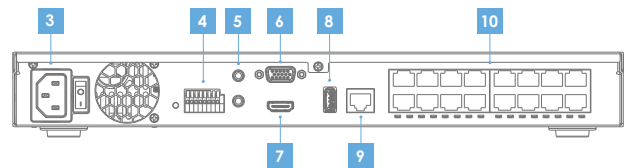

- 8 USB 3.0
- 9 Ethernet
- 10 16 x 802.3at/af PoE ports